

Technical data
Hydraulic lift crane

LR 1280 W
Litronic®

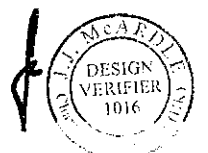
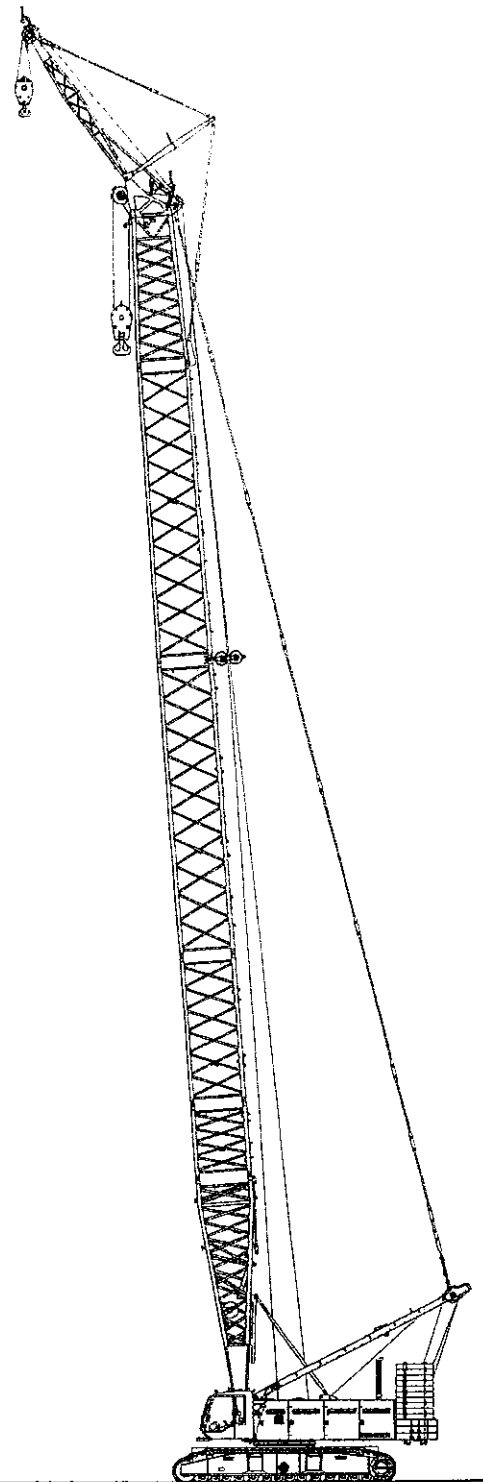

LIEBHERR

1

Dimensions

Basic machine with undercarriage

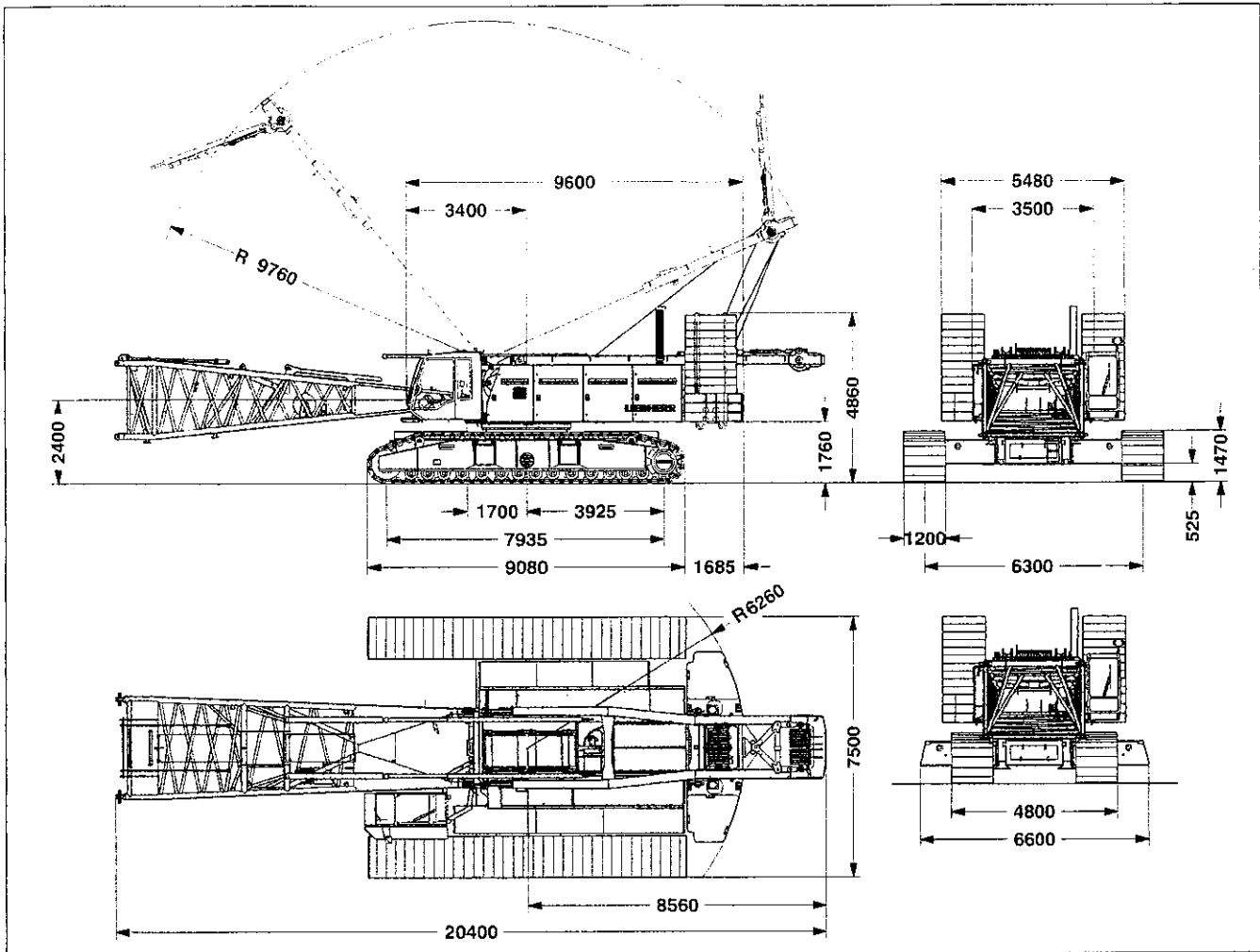

Operating weight

The operating weight includes the basic machine with crawlers, 2 main winches 150 kN and 29 m main boom, consisting of A-frame, boom foot (10 m), boom head (7 m), boom section tapered (12 m), 85.5 t basic counterweight, 32 t carbody counterweight and 300 t hook block.

Total weight approx. 228 t

Ground pressure

Ground bearing pressure 1.20 kg/cm²

Equipment

High reach (No. 2821.xx and 2220.xx) 86 m
 Fixed jib (No. 0906.xx) 7 m
 Auxiliary jib 30 t lifting capacity

Remarks

1. The lifting capacities stated are valid for lifting operation only (corresponds with crane classification according to F.E.M. 1.001, crane group A1).
2. Crane standing on firm, horizontal ground.
3. The weight of the lifting device (hoisting ropes, hook block, shackle etc.) must be deducted from the gross lifting capacity to obtain a net lifting value.
4. Additional equipment on boom (e.g. boom walkways, auxiliary jib) must be deducted to get the net lifting capacity.
5. For max. wind speed please refer to lift chart in operator's cab or manual.
6. Working radii are measured from centre of swing and under load.
7. The lifting capacities are valid for 360 degrees of swing.
8. Calculation of stability under load is based on DIN 15019 / part 2 / chart 1 and ISO 4305 Table 1 + 2, tipping angle 4°.
9. The structures are calculated according to F.E.M. 1.001 – 1998 (prEN 13001 / T2 / 1997).



Transport dimensions and weights

Basic machine and boom (No. 2821.xx – No. 2220.xx)

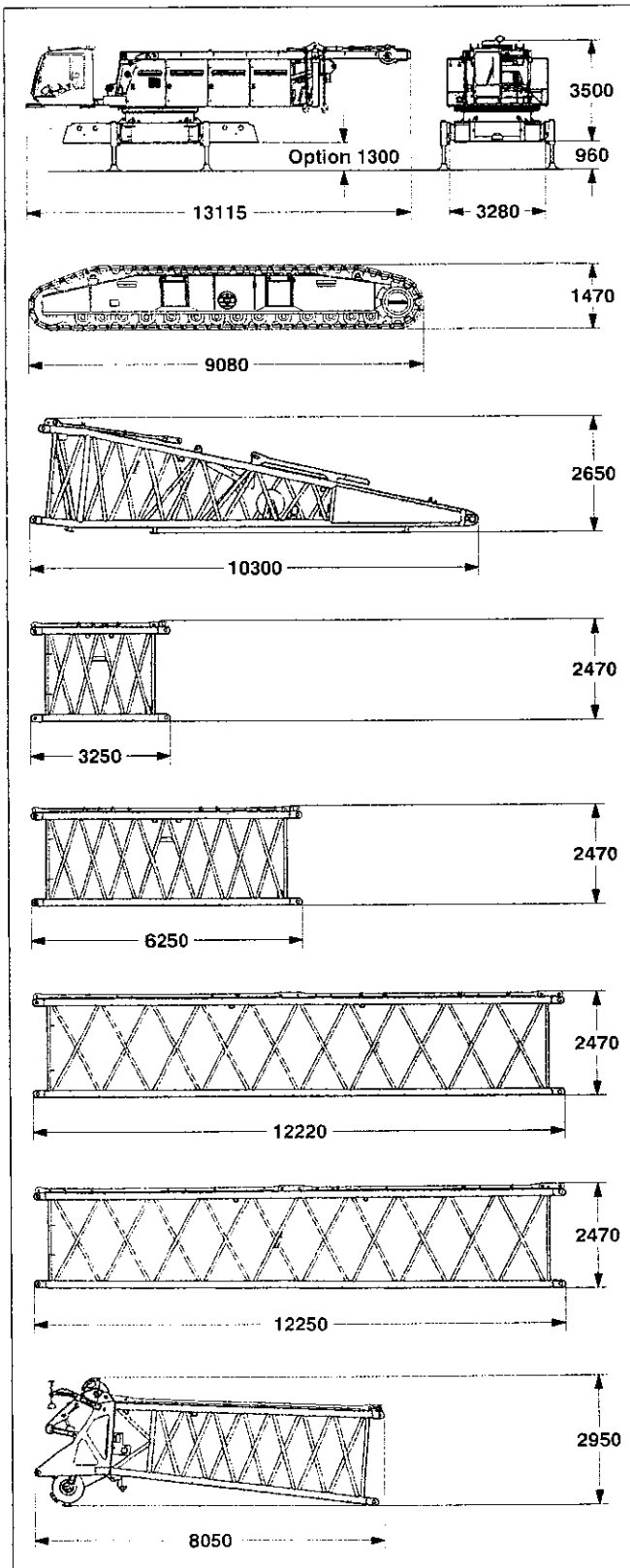

*) Including pendants

Basic machine

with A-frame, 2x 150 kN crane winches including wire ropes (max. 665 m), without crawlers, boom foot, basic counterweight and carbody counterweight

Width _____ mm _____ 3500
Weight _____ kg _____ 45600

Crawler

2x

Flat track shoes _____ mm _____ 1200
Width _____ mm _____ 1250
Weight _____ kg _____ 21500

Boom foot (No. 2821.30)

Width _____ mm _____ 2970
Weight* _____ kg _____ 5700

Boom section (No. 2821.24)

3 m

Width _____ mm _____ 2970
Weight* _____ kg _____ 1100

Boom section (No. 2821.24)

6 m

Width _____ mm _____ 2970
Weight* _____ kg _____ 1700

Boom section (No. 2821.24)

12 m

Width _____ mm _____ 2970
Weight* _____ kg _____ 2900

L - boom

section tapered (No. 2821/2220.24)

12 m

Width _____ mm _____ 2970
Weight* _____ kg _____ 2850

Boom head (No. 2220.xx)

Width _____ mm _____ 2420
Weight* _____ kg _____ 4690

Transport dimensions and weights

Counterweights

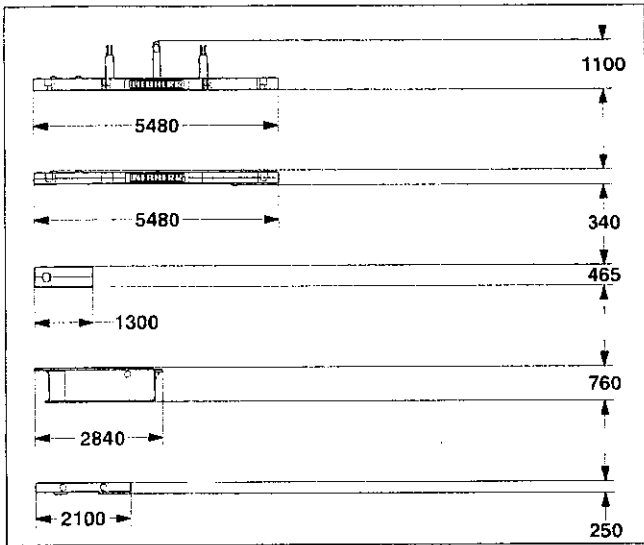

Counterweight 1x

Width _____ mm _____ 1660
 Weight _____ kg _____ 13300

Counterweight 2x

Width _____ mm _____ 1660
 Weight _____ kg _____ 10600

Counterweight 10x

Width _____ mm _____ 1360
 Weight _____ kg _____ 5100

Carbody counterweight 2x

Width _____ mm _____ 1650
 Weight _____ kg _____ 10400

Carbody counterweight 2x

Width _____ mm _____ 1620
 Weight _____ kg _____ 5600

Fixed jib (No. 0906.xx)

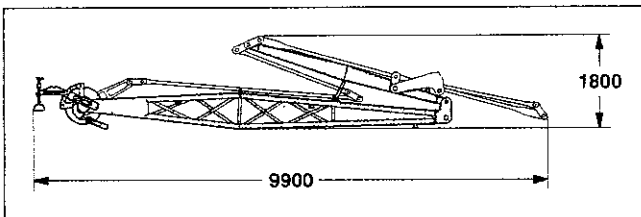

Fixed jib with A-frame

Width _____ mm _____ 2700
 Weight* _____ kg _____ 2350

*) Including pendants

Hooks

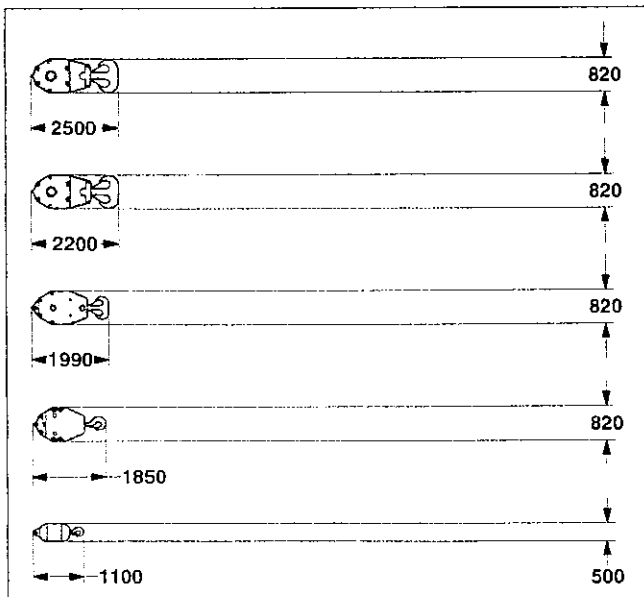

300 t hook block - 11 sheaves

Width _____ mm _____ 880 — 1230
 Weight _____ kg _____ 3200 — 5500

150 t hook block - 5 sheaves

Width _____ mm _____ 500 — 660 — 820
 Weight _____ kg _____ 1600 — 2800 — 4000

100 t hook block - 3 sheaves

Width _____ mm _____ 340 — 480 — 620
 Weight _____ kg _____ 1100 — 2050 — 3000

50 t hook block - 1 sheave

Width _____ mm _____ 280 — 410 — 540
 Weight _____ kg _____ 800 — 1600 — 2400

16 t single hook

Width _____ mm _____ 500
 Weight _____ kg _____ 900

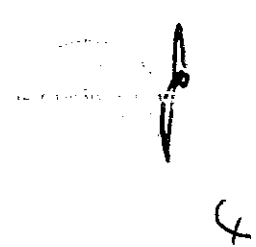

Technical description



Engine

Power rating according to ISO 9249, 400 kW (544 PS) at 1900 rpm
Engine type Liebherr D 9408 TI-E
Fuel tank 2x 460 l capacity with continuous level indicator
and reserve warning
Engine complies with NRMM exhaust certification EPA / CARB Tier 2 and
97/68 EC Stage II



Hydraulic system

An axial displacement pump supplies the open loop hydraulic system for
boom luffing, jib luffing and travel. The main hoist winches and swing are
operated in a closed loop system. All functions can be operated
simultaneously. To minimize peak pressure an automatic working pressure
cut-off is integrated in a pump. All filters are electronically monitored.
The use of synthetic environmentally friendly (biodegradable) oils is possible.
Working pressure max. 350 bar
Oil tank capacity 1090 l



Boom winch

Line pull (3rd layer) 150 kN
Rope diameter 24 mm
Boom up 137 sec. from 15° to 86°



Swing

Consists of rollerbearing with external teeth, swing drive with fixed axial
piston hydraulic motor, spring loaded and hydraulically released
multi-disc holding brake, planetary gearbox and pinion.
Free swing with hydraulic moment control reduces wear to a minimum.
Alternatively the swing control can be changed to simulate closed loop
speed control. Then a multi-disc holding brake acts automatically at zero
swing motion.
Swing speed from 0 – 1.8 rpm continuously variable.



Noise emission

Noise emissions correspond with 2000/14/EC directive on noise emission
by equipment used outdoors.



Main winches

Line pull (1st layer) max. 215 kN
Line pull (7th layer) 150 kN
Rope diameter 28 mm
Drum diameter 730 mm
Rope speed m/min 0 – 138
Rope capacity in 7 layers 570 m

The winches are outstanding in their compact design and easy assembly.
Propulsion is via a planetary gearbox in an oil bath.
Load support by the hydraulic system; additional safety factor provided by a
spring loaded, multi-disc holding brake.
The main winches use pressure controlled, variable flow hydraulic motors.
This system features sensors that automatically adjust oil flow to provide max.
winch speed depending on load.
Option – winch with freefall system:
Clutch and braking functions on the freefall system are provided by a compact
designed, low wear and maintenance free multi-disc brake.



Crawlers

Propulsion through axial piston motor, hydraulically released spring loaded
multi-disc brake, crawler tracks, hydraulic chain tensioning device.
Flat track shoes 1200 mm
Drive speed 0 – 1.3 km/h



Control

The control system – developed and manufactured by Liebherr – is
designed to withstand extreme environmental conditions such as
temperature, vibration and electromagnetic interference and to meet all
requirements that are needed in heavy duty crane operation.
Complete machine operating data are shown on a high resolution display.
Standard operational information is displayed by means of graphical
symbols, fault indications are displayed in plain text (more than 10
languages available).
The cranes are equipped with proportional control for all main movements,
which can be carried out simultaneously.
A backup control system, that allows limited use of the crane is standard.
This feature increases the safety and availability of the crane even further.
The crane is operated with 2 multi-directional joysticks, the right for winch I
and boom, the left for winch II and swing control.
Option:
Bi-directional double T-levers for simultaneous boom and luffing jib
operation.
The crawlers are activated by the two central foot pedals. Additionally,
hand levers can be attached to the pedals.



L - boom high reach (No.2821 / 2220.xx) **86 m**

Working range 86° - 15°

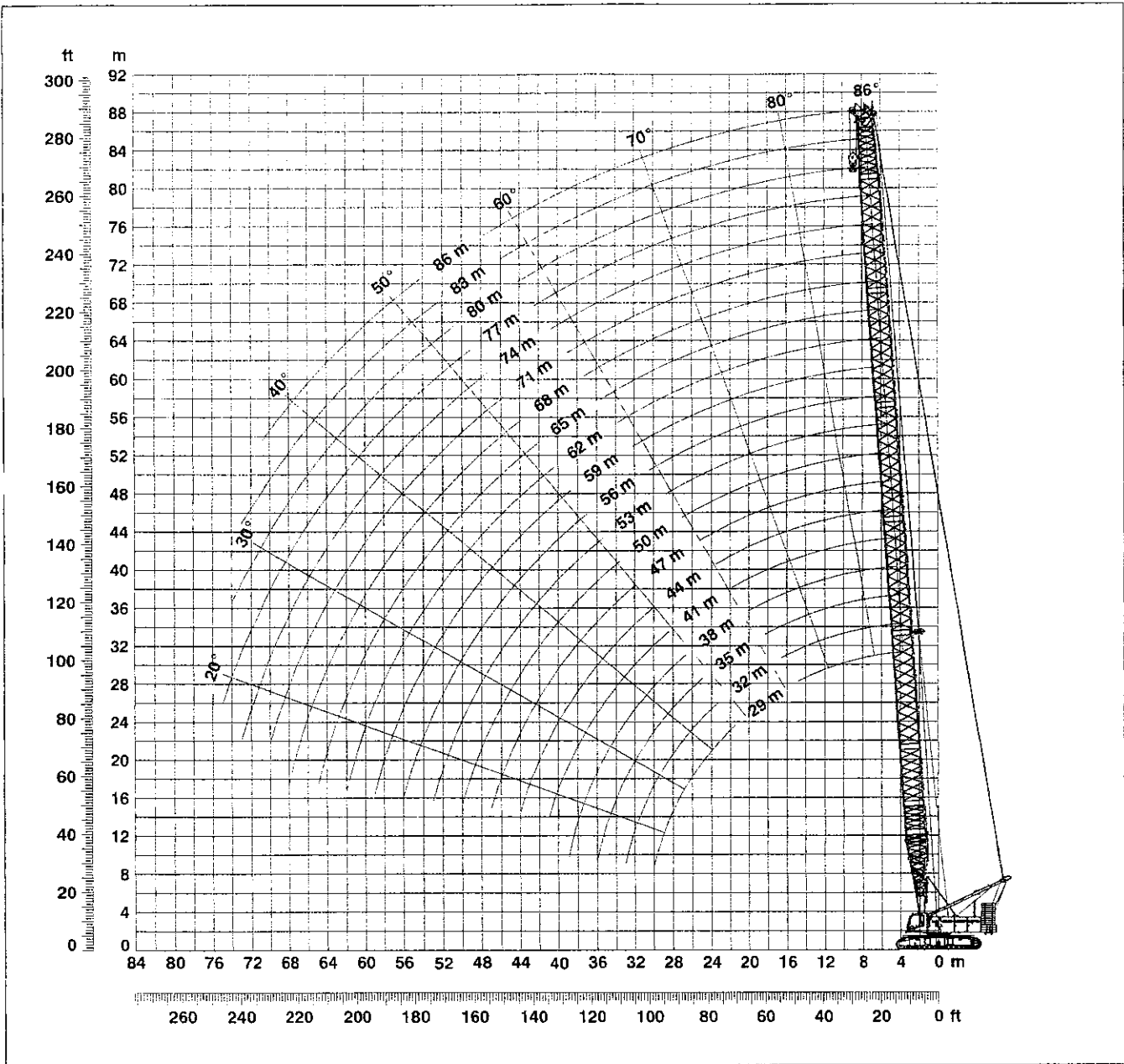

L - boom configuration (No. 2821.xx / No. 2220.xx)

Configuration for L - boom lengths (29m - 86 m)

Length	Amount of boom and luffing jib extensions																			
	1	1	1	1	1	1	1	1	1	1	1	1	1	1	1	1	1	1	1	1
Boom foot 10.0 m	1	1	1	1	1	1	1	1	1	1	1	1	1	1	1	1	1	1	1	1
Boom insert 3.0 m		1		1		1		1		1		1		1		1		1		1
Boom insert 6.0 m			1	1			1	1			1	1			1	1			1	1
Boom insert 12.0 m					1	1	1	1	2	2	2	2	3	3	3	3	4	4	4	4
Tapered 12.0 m	1	1	1	1	1	1	1	1	1	1	1	1	1	1	1	1	1	1	1	1
Luffing jib head 7.0 m	1	1	1	1	1	1	1	1	1	1	1	1	1	1	1	1	1	1	1	1
Max. L - boom length (m)	29	32	35	38	41	44	47	50	53	56	59	62	65	68	71	74	77	80	83	86



Lift chart for L - boom (No. 2821 / 2220.xx)

Capacities in metric tons for boom lengths (29 m – 86 m) – with 150 kN winches
85.5 t counterweight and 32.0 t carbody counterweight

Radius (m)	Boom length (m)											Radius (m)	
	29	38	44	50	56	62	68	74	80	83	86		
	t	t	t	t	t	t	t	t	t	t	t	t	
4.9	250.7												4.9
5	250.7												5
6	219.0	201.6	182.8										6
7	175.9	169.6	158.6	148.7	134.0								7
8	160.7	146.0	137.6	127.0	122.8	116.3	102.7						8
9	134.1	125.6	119.8	114.6	109.3	103.9	98.9	89.1	78.0	73.0	68.2		9
10	120.5	113.8	107.3	103.0	98.2	93.7	89.5	82.8	77.3	73.0	68.2		10
12	98.3	91.4	88.8	84.9	79.4	77.3	74.7	70.9	64.4	62.4	59.8		12
14	81.9	77.9	74.8	67.8	69.0	66.3	61.8	60.2	54.7	54.6	52.4		14
16	67.9	66.9	64.4	61.9	55.0	54.9	55.2	51.0	48.2	47.3	45.5		16
18	57.7	57.2	55.9	54.2	52.3	49.4	48.4	46.5	43.4	40.8	38.6		18
20	49.9	49.4	49.2	48.0	46.3	43.9	39.9	38.7	38.9	37.7	36.1		20
22	43.8	43.3	43.0	42.6	41.2	39.8	38.2	35.4	34.6	33.6	32.3		22
24	38.8	38.4	38.1	37.6	37.2	35.8	34.5	32.9	31.1	30.1	26.0		24
26	34.7	34.3	34.0	33.6	33.2	32.4	31.1	28.7	27.7	26.0	24.6		26
28	31.2	30.8	30.6	30.1	29.3	29.2	27.7	26.8	25.9	24.9	23.4		28
30	28.2	27.9	27.7	27.2	26.8	26.3	25.8	24.6	23.5	23.0	21.9		30
32		25.4	25.1	24.7	24.3	23.8	23.3	22.5	21.4	20.9	20.3		32
34		23.2	22.9	22.5	22.1	21.6	21.1	20.5	19.5	19.0	18.5		34
36		21.2	21.0	20.6	20.2	19.6	19.2	18.7	17.9	17.4	16.8		36
38		19.4	19.3	18.8	18.5	17.9	17.5	16.9	16.4	15.9	15.4		38
40			17.7	17.3	16.9	16.4	16.0	15.4	14.2	14.6	14.1		40
42			16.3	15.9	15.6	14.9	14.7	13.7	13.4	13.4	12.9		42
44			15.1	14.8	14.4	13.9	13.4	12.9	12.4	12.1	11.8		44
46				13.6	13.3	12.8	12.3	11.8	11.3	11.0	10.7		46
48				12.6	12.2	11.7	11.3	10.7	10.2	10.0	9.7		48
50				11.6	11.3	10.8	10.3	9.8	9.3	9.0	8.7		50
55					9.2	8.7	8.3	7.7	7.3	7.0	6.7		55
60						7.0	6.6	6.1	5.6	5.3	5.0		60
65							5.1	4.6	4.1	3.9	3.6		65
70								3.4	2.9	2.7	2.4		70

Above lift chart is for reference only. For actual lift duty please refer to lift chart in operator's cab or manual.



Working range - fixed jib (No. 0906.xx) 30°

Main boom 88°- 30°

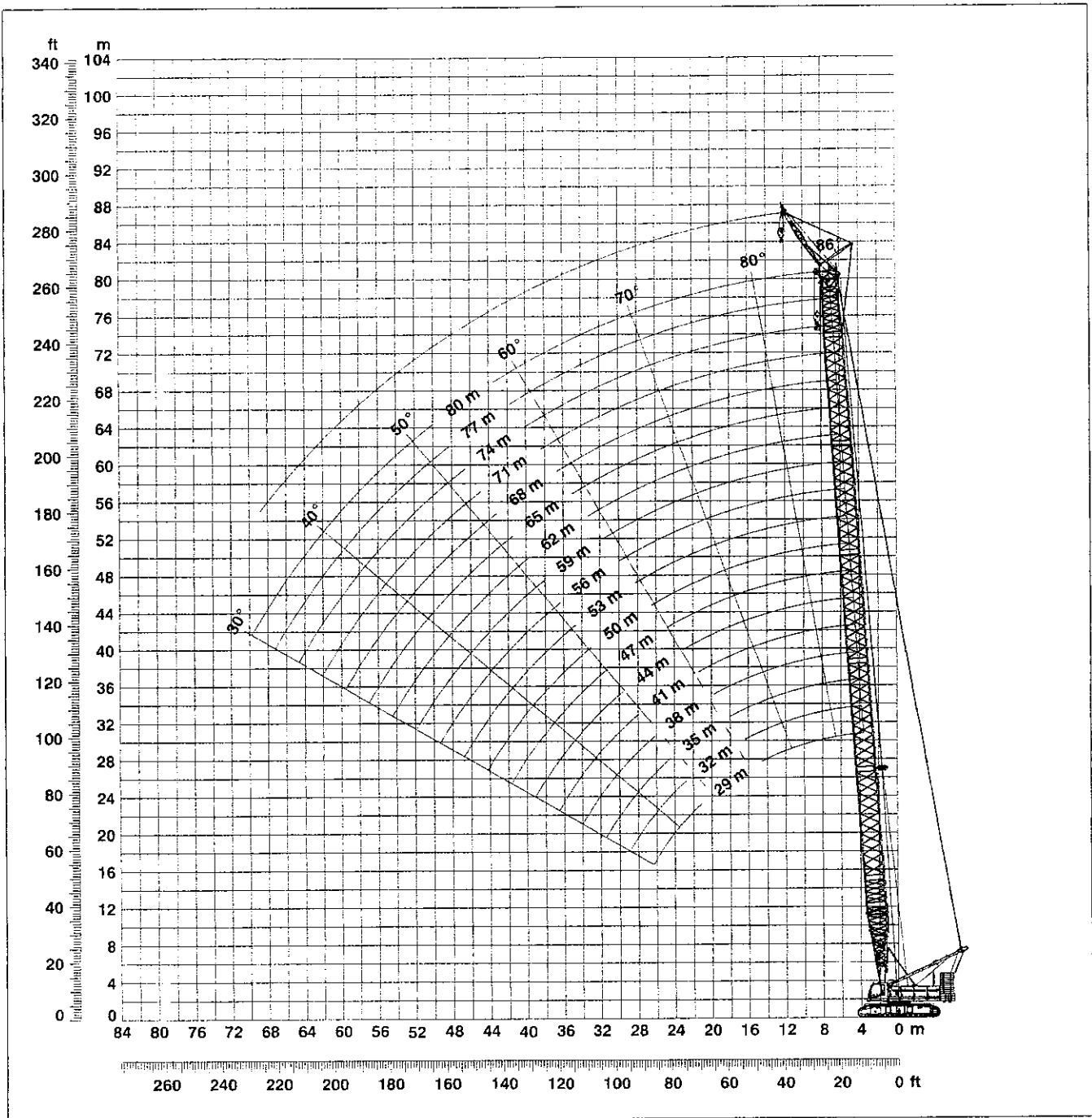

Boom configuration for boom lengths (29 m – 80 m) – see table 1 on page 6



Lift chart - fixed jib (No. 0906.xx) 7 m

Offset 30°

Main boom 29 m

Radius (m)	t
7.3	74.1
10	70.8
12	68.6
14	66.4
16	62.3
18	58.8
20	50.9
22	44.6
24	39.5
26	35.3
28	31.8
30	28.8
32	26.2
34	23.8

Main boom 32 m

Radius (m)	t
7.5	80.0
10	75.9
12	71.5
14	67.7
16	63.7
18	58.6
20	50.7
22	44.4
24	39.3
26	35.1
28	31.6
30	28.6
34	23.7
36	21.7

Main boom 38 m

Radius (m)	t
7.7	83.4
10	77.8
12	73.7
14	69.4
16	65.5
18	56.1
20	50.3
22	44.0
24	39.0
26	34.8
30	28.2
34	23.3
38	19.6
42	16.5

Main boom 44 m

Radius (m)	t
7.9	82.8
10	78.9
12	74.5
14	70.7
16	63.1
18	55.3
22	43.7
26	34.4
30	27.9
34	23.0
38	19.3
42	16.2
46	13.8
48	12.7

Main boom 50 m

Radius (m)	t
8.1	82.2
10	79.3
12	75.3
14	70.4
16	60.8
20	47.2
24	37.9
28	30.5
32	24.8
36	20.6
40	17.2
44	14.6
48	12.3
50	11.3

Main boom 56 m

Radius (m)	t
8.3	81.6
10	79.6
12	76.1
14	67.8
16	56.9
20	45.5
24	36.6
28	29.6
32	24.4
36	20.2
40	16.8
44	14.2
50	11.0
55	8.8

Main boom 62 m

Radius (m)	t
8.5	80.9
10	79.9
12	76.3
14	65.2
16	56.5
20	43.9
24	35.2
28	28.8
32	24.0
36	19.7
40	16.3
44	13.7
50	10.5
60	6.5

Main boom 65 m

Radius (m)	t
8.6	80.5
10	80.0
12	74.9
16	55.5
20	43.1
24	34.6
28	28.3
32	23.5
36	19.5
40	16.1
44	13.5
50	10.3
60	6.4
65	4.9

Main boom 68 m

Radius (m)	t
8.7	77.6
10	77.4
12	73.3
16	54.4
20	42.3
24	33.9
28	27.3
32	22.9
36	19.2
40	15.9
44	13.2
50	10.0
60	6.1
65	4.6

Main boom 74 m

Radius (m)	t
8.9	73.3
10	73.3
12	69.8
16	52.4
20	40.7
24	32.6
28	26.3
32	21.9
36	18.2
40	15.2
44	12.7
50	9.5
60	5.6
70	2.8

Main boom 77 m

Radius (m)	t
9	72.8
10	72.8
12	69.2
16	51.5
20	40.0
24	32.0
28	26.0
32	21.4
36	17.8
40	14.1
44	12.4
50	9.3
60	5.4
70	2.6

Main boom 80 m

Radius (m)	t
9.1	72.2
10	72.2
12	67.8
16	50.5
20	39.2
24	31.3
28	25.4
32	20.9
36	17.3
40	13.8
44	12.0
50	9.0
60	5.1
70	2.3

Capacities in metric tons with fixed jib (No. 0906.xx) 85.5 t counterweight + 32 t carbody counterweight. Above lift chart is for reference only. For actual lift duty and complete chart with all available configurations please refer to lift chart in operator's cab or manual.

Boom combinations

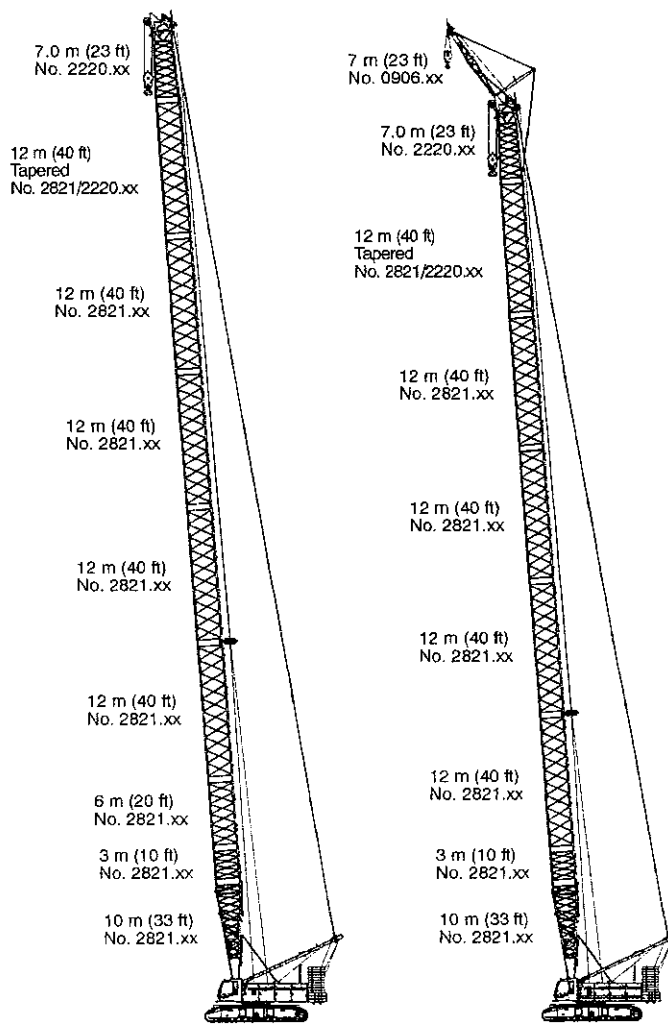

Max. combination ——— 86 m
 Main boom No. 2821.xx — 67 m
 Tapered No. 2821/2220.xx — 12 m
 Boom head No. 2220.xx — 7 m

Max. combination ——— 87 m
 Main boom No. 2821.xx — 80 m
 Fixed jib No. 0906.xx — 7 m



Self assembly system

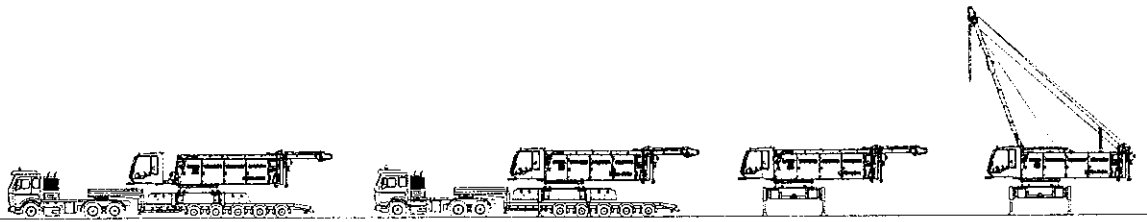

Unloading of basic machine

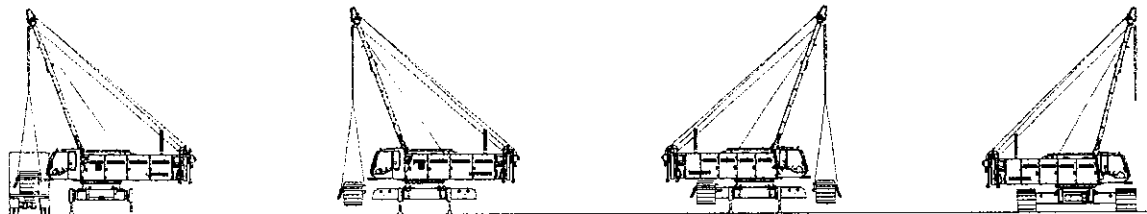

Unloading and assembly of crawlers

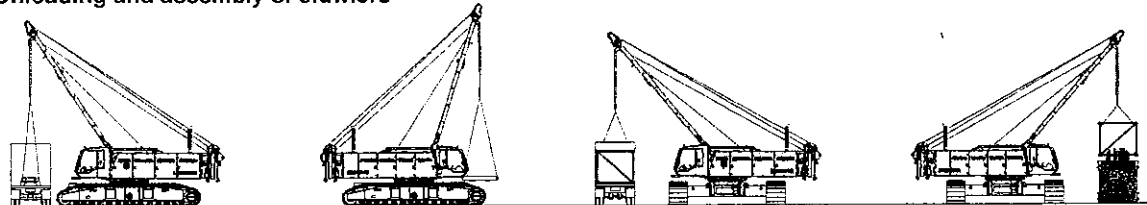

Unloading and assembly of carbody counterweight

Unloading and assembly of boom

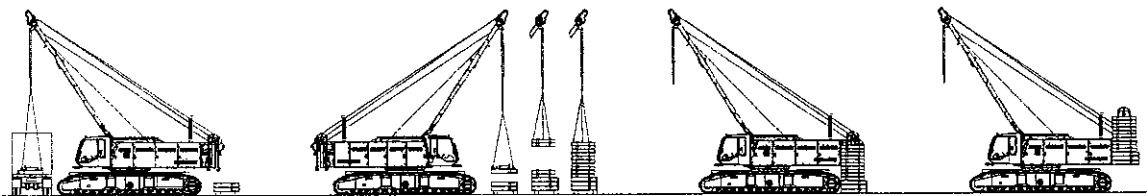

Unloading and assembly of counterweight

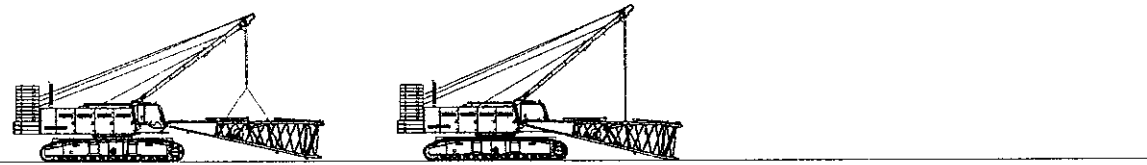

Unloading and assembly of boom foot

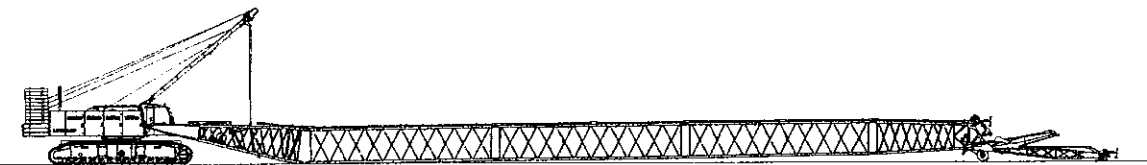

Assembly of boom

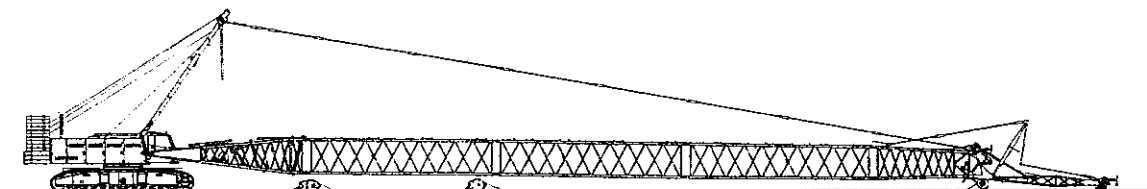

Reeving of hoist and fixed jib ropes

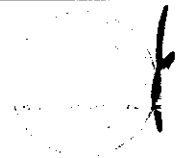

Main boom+ tapered insert

Load capacity charts

The machine is rated according to ISO 4301/1 and /2 in crane group A1 (Q1, U2) (see chapter 2 "Equipment rating" in the operating manual).

The load capacities have been calculated to:

- EN 13000 : 2004
- EN 13001-1 : 2004
- EN 13001-2 : 2004

The load capacities are only applicable to machines standing on horizontal (tolerance 1%, 1%), solid and sufficiently supportive subsoil.

The machine operator must not drive into areas other than those specified in the load capacity charts. Outreaches with no load capacity value are not permitted.

The outreach is the radius measured between the centre of the slewing ring and the center of the load hook or the pulley block. Different outreaches at the same boom angle result from different reevings. The LML (load moment limitation) on the machine takes this change into account.

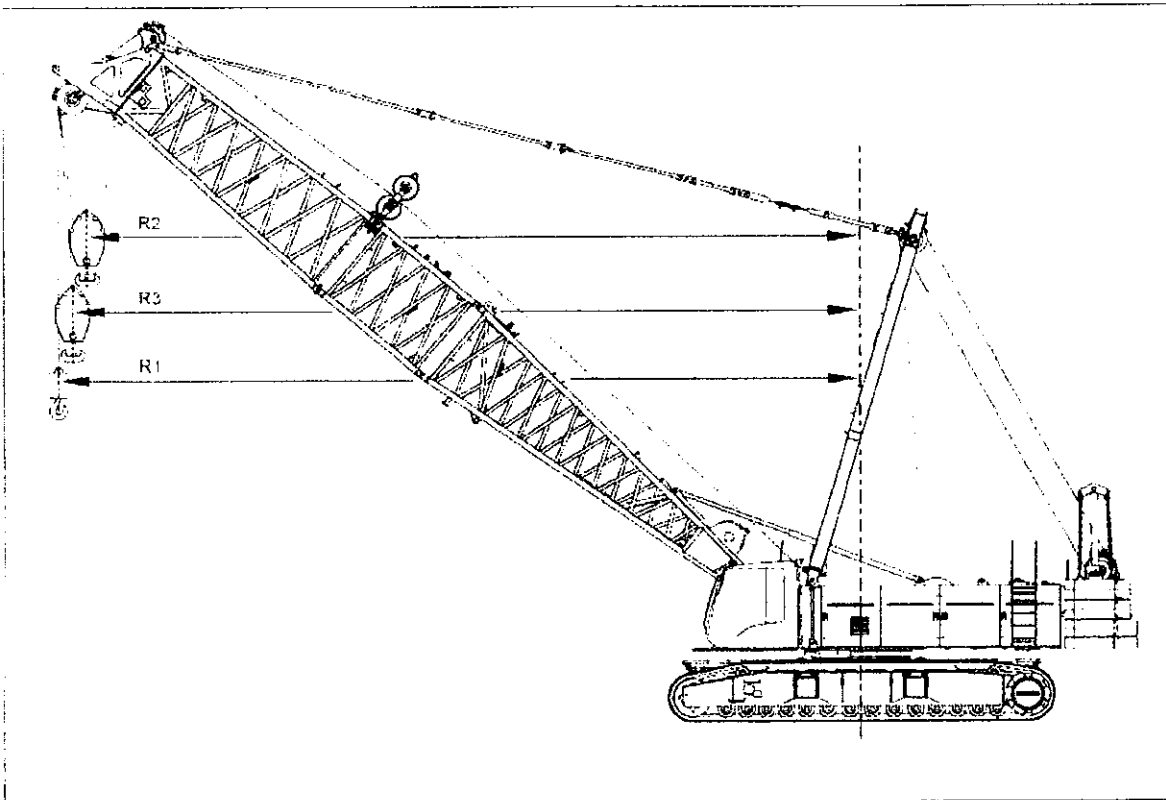

R1	Single reeved hoisting cable
R2	Double reeved hoisting cable
R3	Triple to n-times reeved hoisting cable

The outreach (radius) in the load capacity chart always refers to R3.

[Handwritten signature]
12

Main boom+ tapered insert

These load capacity charts are only applicable to original LIEBHERR machine and boom components that are new and in perfect condition. Any form of damage, any modification or addition that has not been approved by LIEBHERR invalidates the following load capacities, which in such cases must not be applied.

The values shown on a grey background are load capacities that are limited by the structure of the machine. All values shown with a white background are tilting load values.

The suspended hoisting ropes, the load hook/pulley block and the slinging equipment form part of the load. These weights must always be deducted from the value shown in the table. The per-meter weight of the rope is stated in the Rope Certificate.

The rated rope pull of the hoisting winches is 150kN. The reeving should be selected in such a way that this value is not exceeded. The tables below show the reevings and the associated maximum load capacities. The efficiency of the rope drive has been taken into account in these tables.

Boom head 2220-1	2220.24	7m	10 rope pulleys (maximum reeving: 18)
------------------	---------	----	---------------------------------------

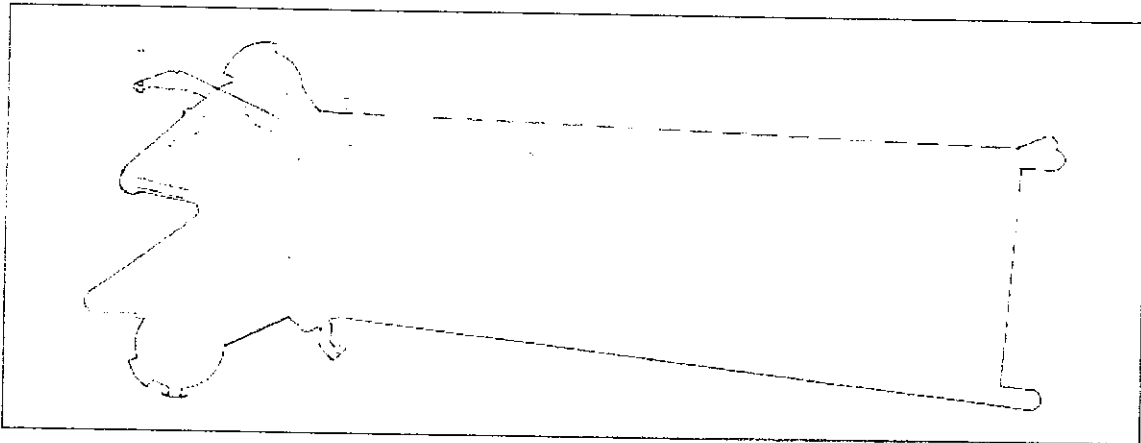

Reeving	1	2	3	4	5	6	7	8	9	10
Load capacity [t]	15.1	30.1	45.0	59.7	74.2	88.6	102.9	117.0	131.0	144.8

Reeving	11	12	13	14	15	16	17	18
Load capacity [t]	158.5	172.1	185.5	198.8	212.0	225.0	237.9	250.7

Boom head 2220-2	2220.24	7.77m	1 rope pulley (maximum reeving: 2)
------------------	---------	-------	------------------------------------

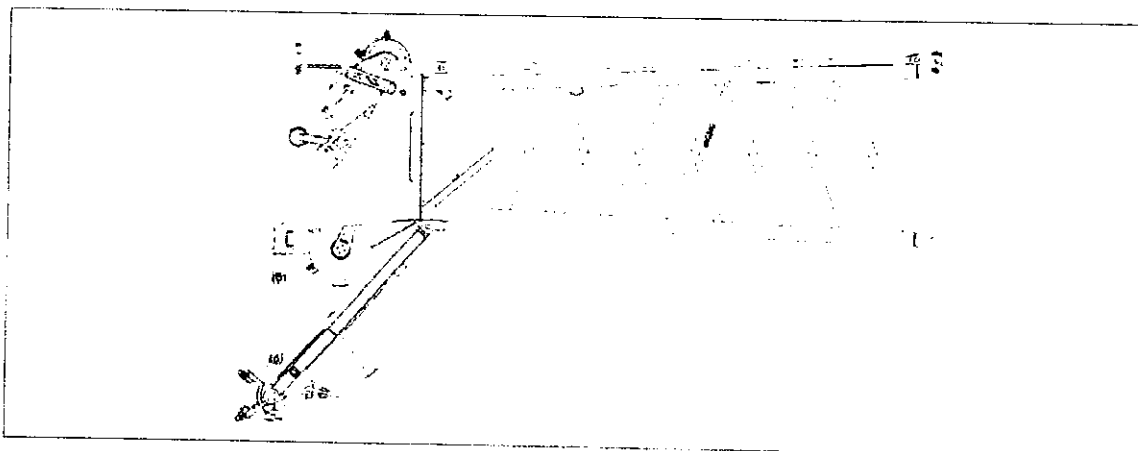

Reeving	1	2
Load capacity [t]	15.1	30.1

Handwritten signature
B

Main boom+ tapered insert

Tapered insert 2821/2220-1	2821/2220,24	12m
----------------------------	--------------	-----

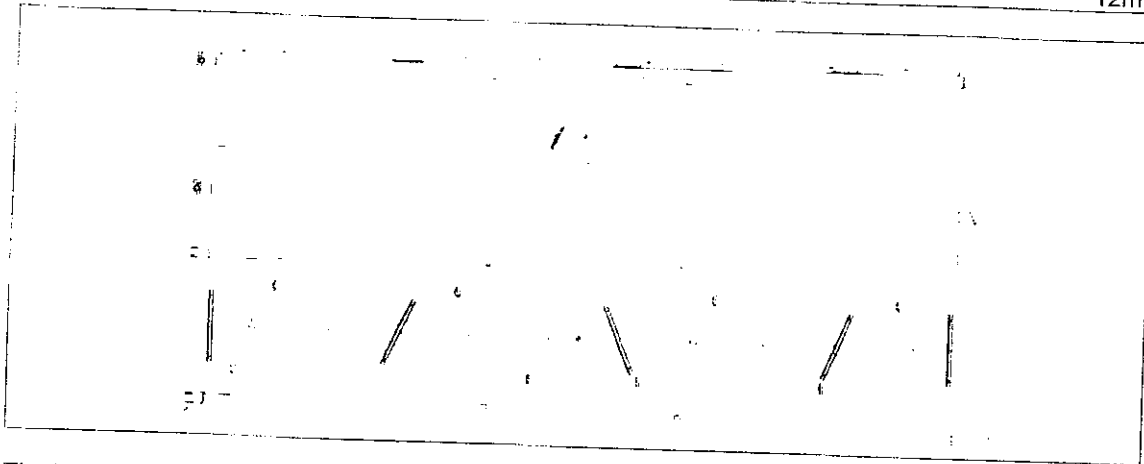

The load capacities for the tip boom have been calculated on the assumption that an unladen pulley block with a dead weight of 3t is reeved at the load fall point main boom head. Load capacity charts are only provided for self-erecting boom lengths.

The pulley block should be reeved in accordance with the reeving diagrams in chapter 6 of the operating manual.

To ensure that at minimum radius the pulley block can always be lowered to the ground, the maximum possible reeving, which depends on the hoisting rope (rope length) used, must be checked. More details can be found in chapter 6 "Required hoist rope length" of the operating manual.

The machine is approved for use in an outside temperature range from -20°C to +40°C.

The load capacities were calculated with the following wind speeds:

Main boom length [m]	maximum permissible wind speed [m/s]
29 - 68	16
71 - 74	14
77 - 86	12

The machine must not be used when wind speeds exceed those shown in the table. In exceptional circumstances loads may be hoisted in wind speeds exceeding those shown in the table, but only with extreme caution and attention. The load must then be reduced in accordance with the table shown below. This table shows minimum values. Responsibility for reducing the load lies with the machine operator.

Main boom length [m]	29 - 68	71 - 74	77 - 86
Wind speed [m/s]	Reduction by: [%]		
10	0	0	0
12			10
14		20	
16			over 16
over 16			

Chapter 5 "Boom park position" of the operating manual describes the permitted park positions of the machine.

If a wind speed in excess of 22m/s is expected or has been forecast, then the entire boom must be laid flat on the ground (see chapters 3 and 5 of the operating manual).

The wind load applied in the load capacity calculation is based on 1.2m²/t of the load. If this ratio is greater for light loads with a large surface area, then the manufacturer should be asked to provide details of the reduced load capacities in advance.

The machine operator must hold the qualifications stated in chapter 3 "Personal attributes required of the machine operator" of the operating manual. The machine operator and all other personnel who are involved with its operation must have read and understood the national regulations on safety and accident prevention.

When moving with a load, higher stability factors apply as specified in EN 13000 : 2004 (tilting angle) and ISO 4305 tables 1 and 2. The manufacturer has drawn up the following simplified version of the rule for the load capacity values:

Load capacity - 10%
Load capacity - 1000kg

The lower value must be used.

The machine must only be moved very slowly (less than 0.4m/s) and only when the subsoil is level and firm. Any dynamic effects must be reduced to the absolute minimum. The load must not be allowed to sway. See also chapter 5 "Moving the machine" of the operating manual.

